

1. TORREGROSA PINA Laura, Shidokan

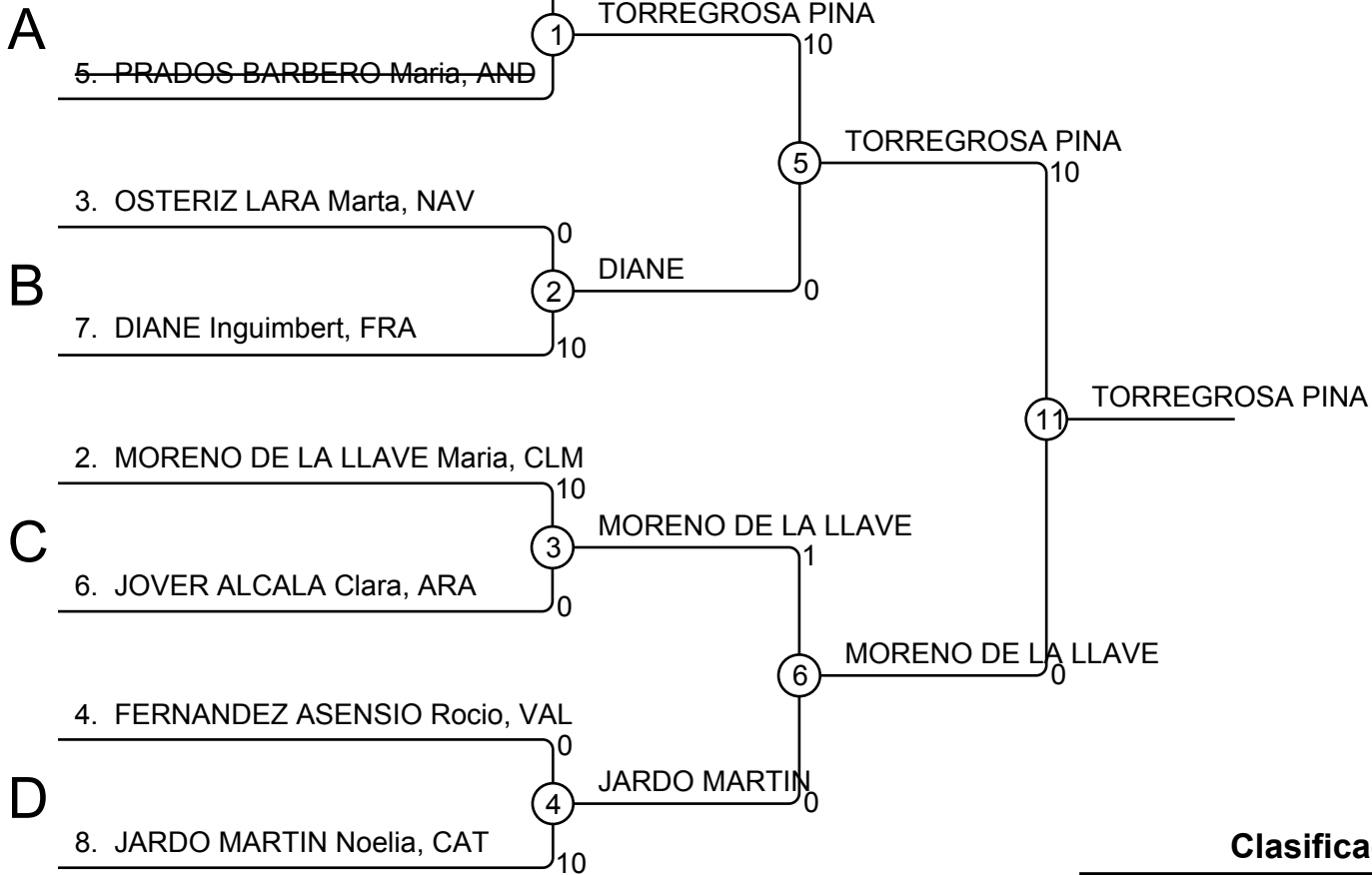

**Clasificación**

Pos.	Nombre
1	TORREGROSA PINA Laura, CLM
2	MORENO DE LA LLAVE Maria, CLM
3	JARDO MARTIN Noelia, CAT
3	DIANE Inguibert, FRA
5	OSTERIZ LARA Marta, NAV
5	FERNANDEZ ASENSIO Rocio, VAL
7	
7	JOVER ALCALA Clara, ARA

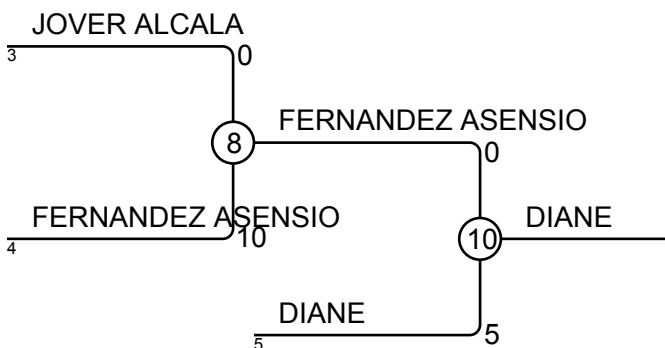
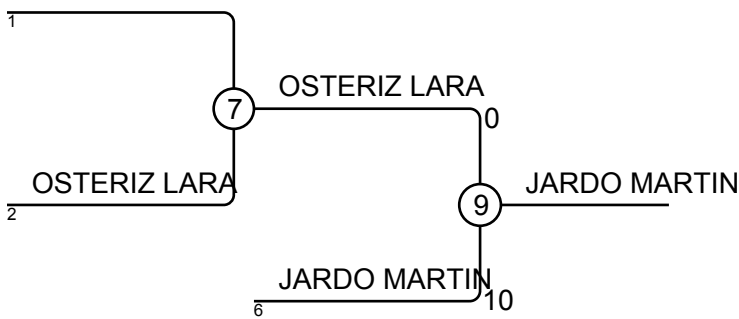

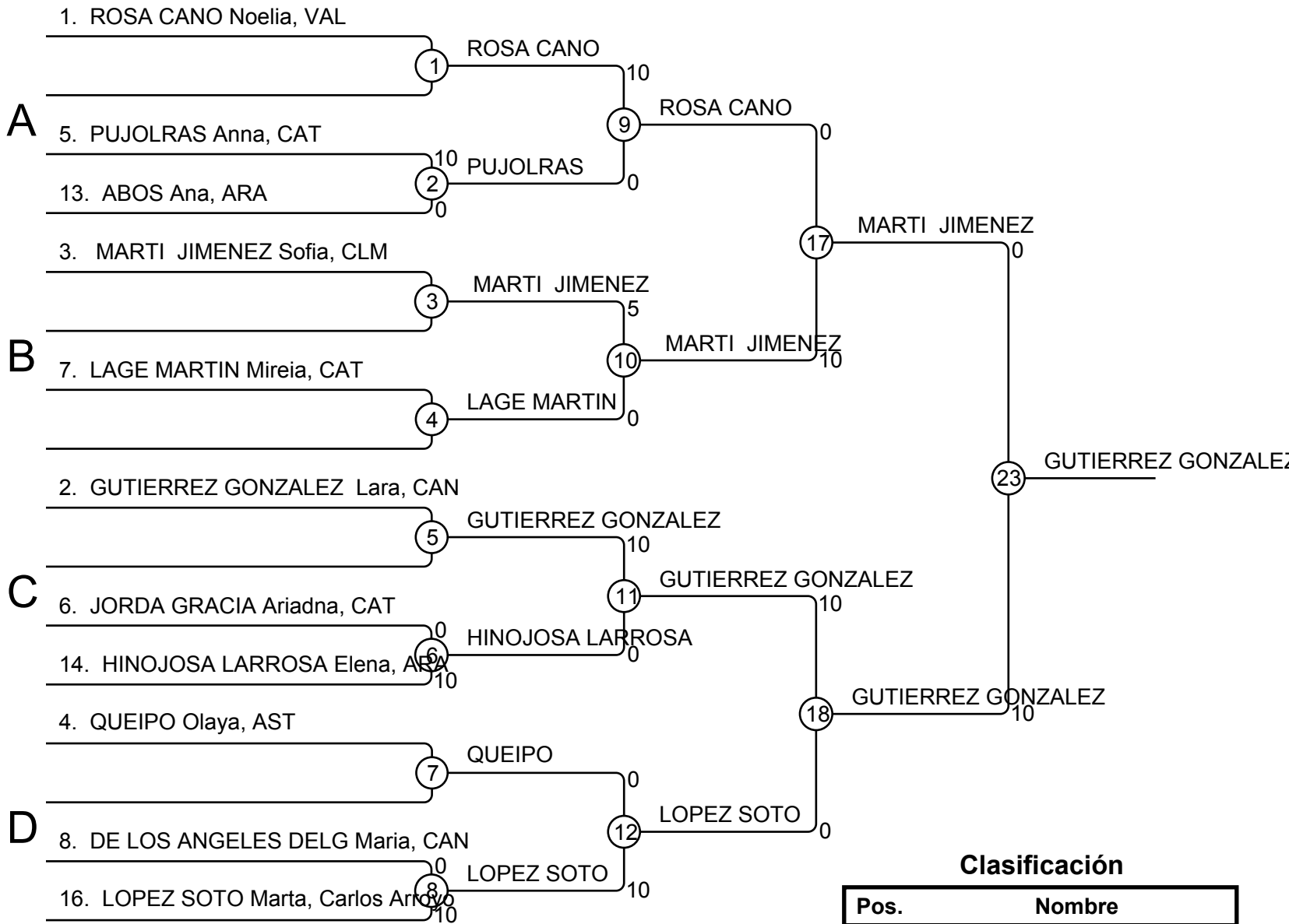

**Clasificación**

Pos.	Nombre
1	GUTIERREZ GONZALEZ Lara, CAN
2	MARTI JIMENEZ Sofia, CLM
3	LOPEZ SOTO Marta,
3	ROSA CANO Noelia, VAL
5	LAGE MARTIN Mireia, CAT
5	QUEIPO Olaya, AST
7	PUJOLRAS Anna, CAT
7	HINOJOSA LARROSA Elena, ARA

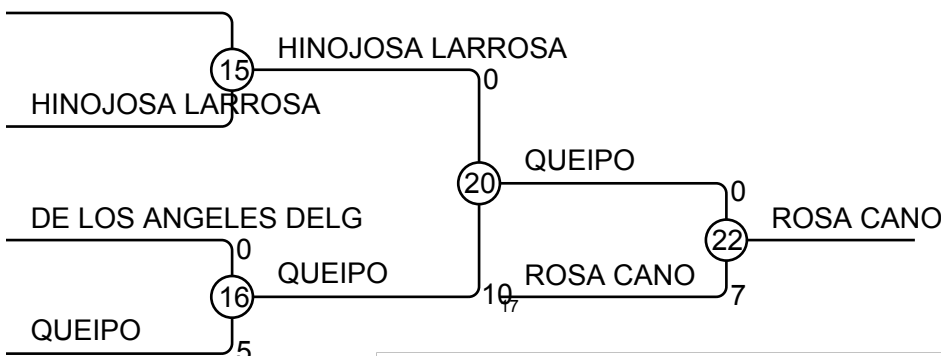
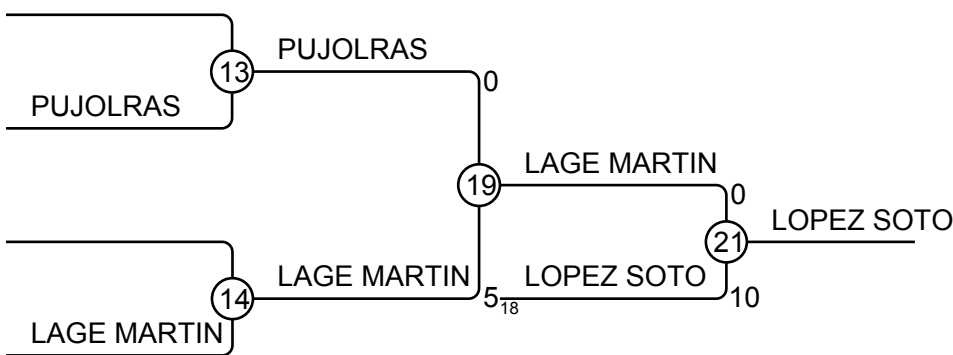

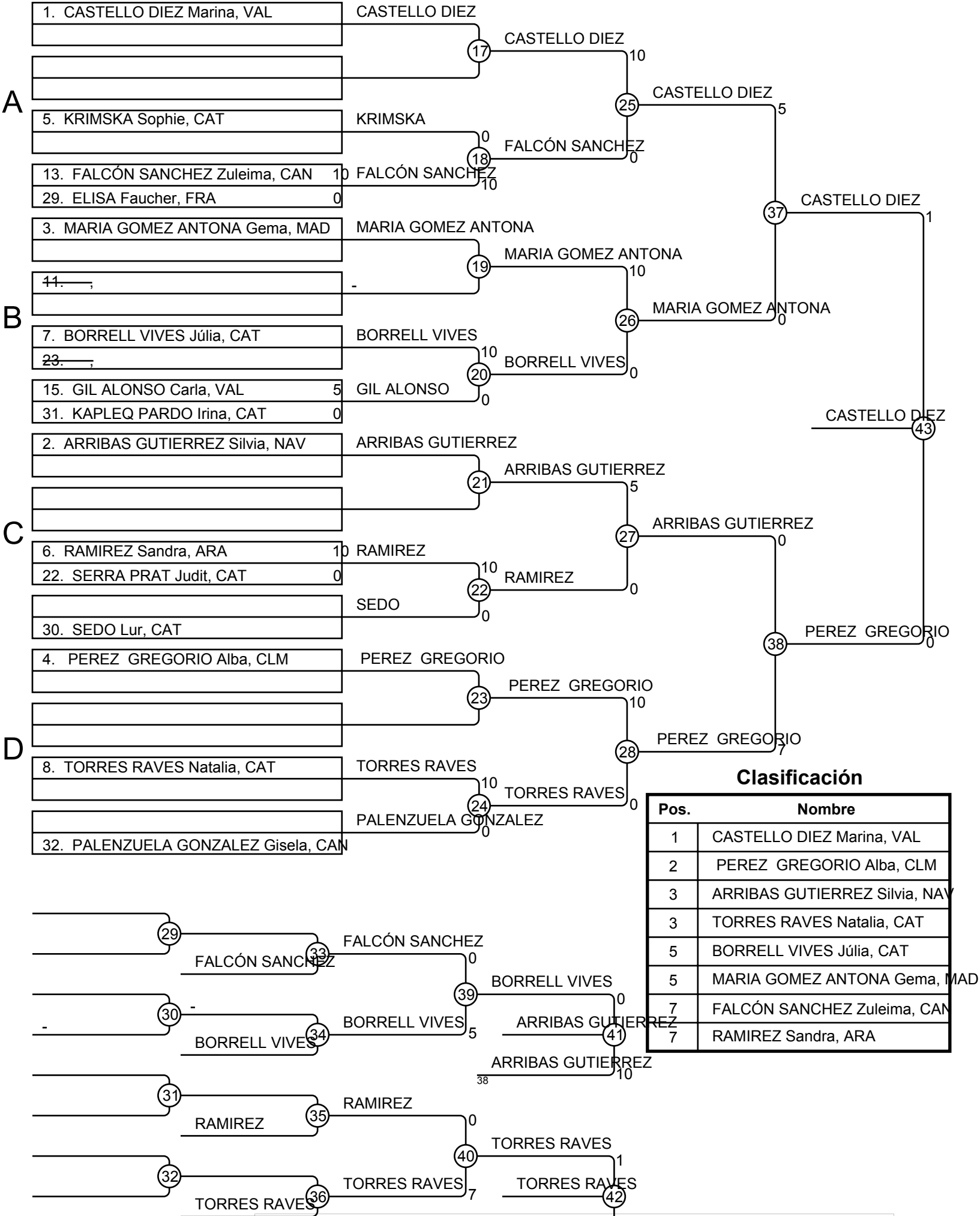

**Clasificación**

Pos.	Nombre
1	CASTELLO DIEZ Marina, VAL
2	PEREZ GREGORIO Alba, CLM
3	ARRIBAS GUTIERREZ Silvia, NAV
3	TORRES RAVES Natalia, CAT
5	BORRELL VIVES Júlia, CAT
5	MARIA GOMEZ ANTONA Gema, MAD
7	FALCÓN SANCHEZ Zuleima, CAN
7	RAMIREZ Sandra, ARA

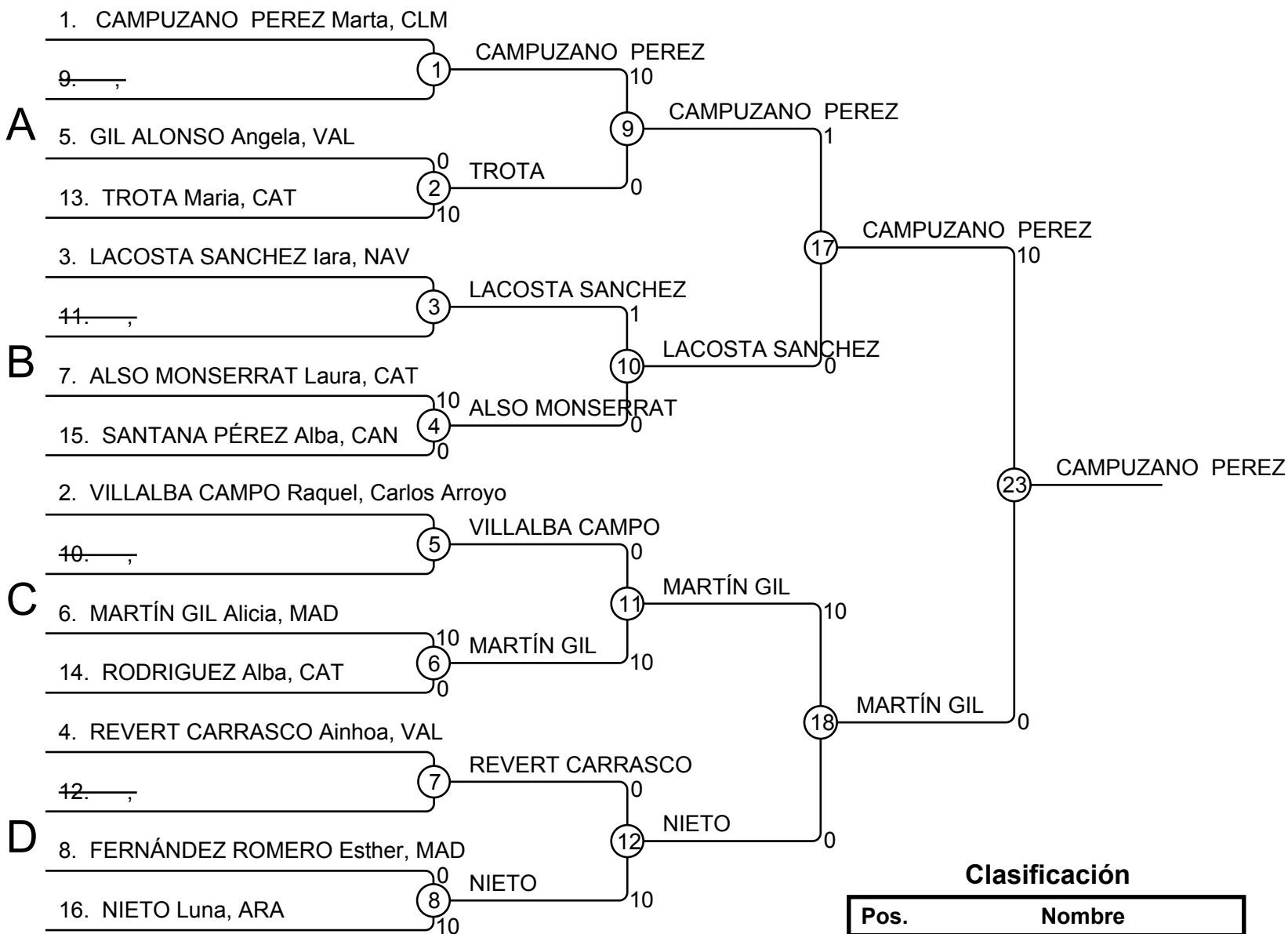

**Clasificación**

Pos.	Nombre
1	CAMPUZANO PEREZ Marta, CLM
2	MARTÍN GIL Alicia, MAD
3	TROTA Maria, CAT
3	VILLALBA CAMPO Raquel,
5	NIETO Luna, ARA
5	LACOSTA SANCHEZ Iara, NAV
7	ALSO MONSERRAT Laura, CAT
7	REVERT CARRASCO Ainhoa, VAL

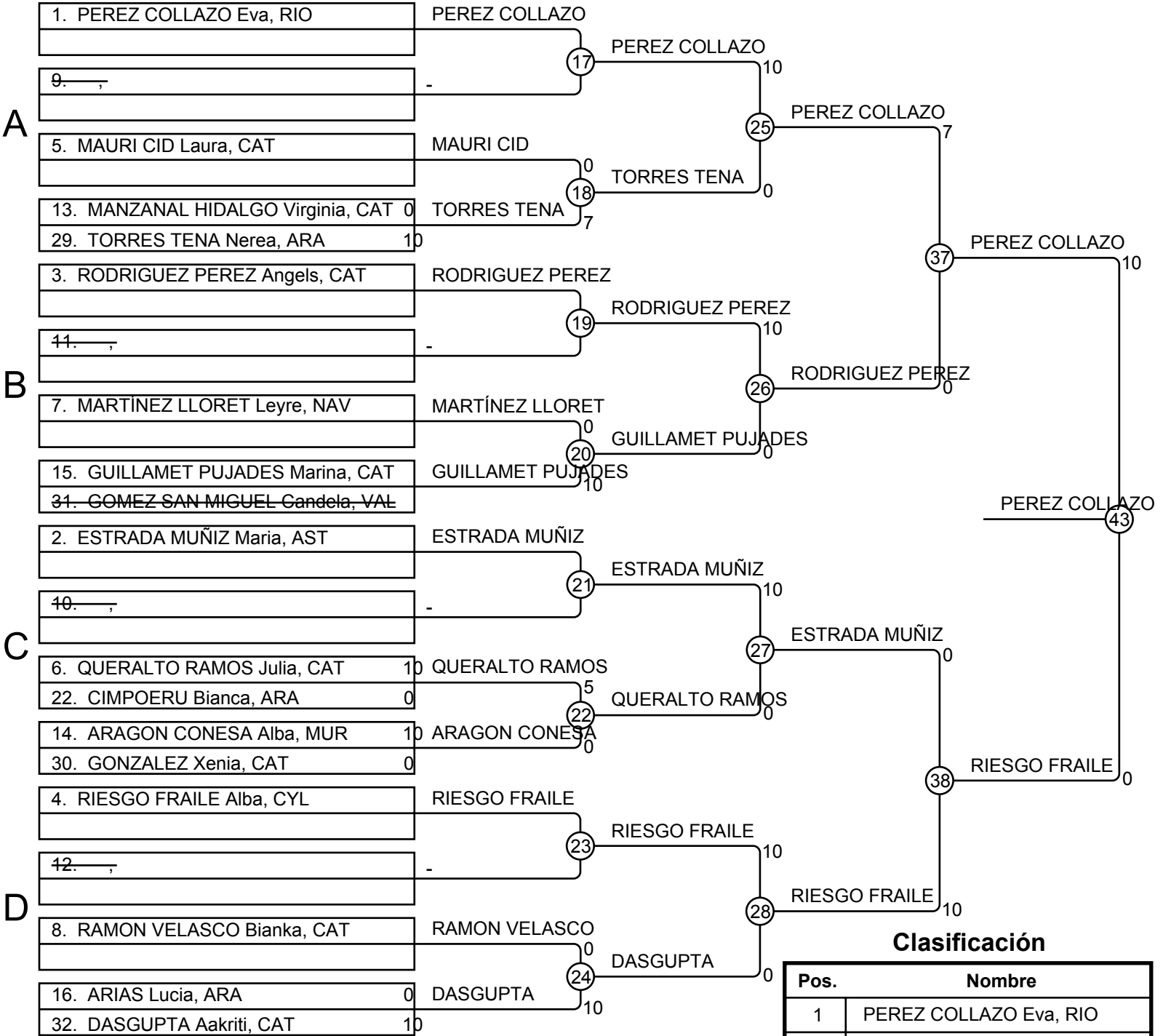

**Clasificación**

Pos.	Nombre
1	PEREZ COLLAZO Eva, RIO
2	RIESGO FRAILE Alba, CYL
3	ESTRADA MUÑIZ Maria, AST
3	DASGUPTA Aakriti, CAT
5	TORRES TENA Nerea, ARA
5	RODRIGUEZ PEREZ Angels, CAT
7	GUILLAMET PUJADES Marina, CAT
7	QUERALTO RAMOS Julia, CAT

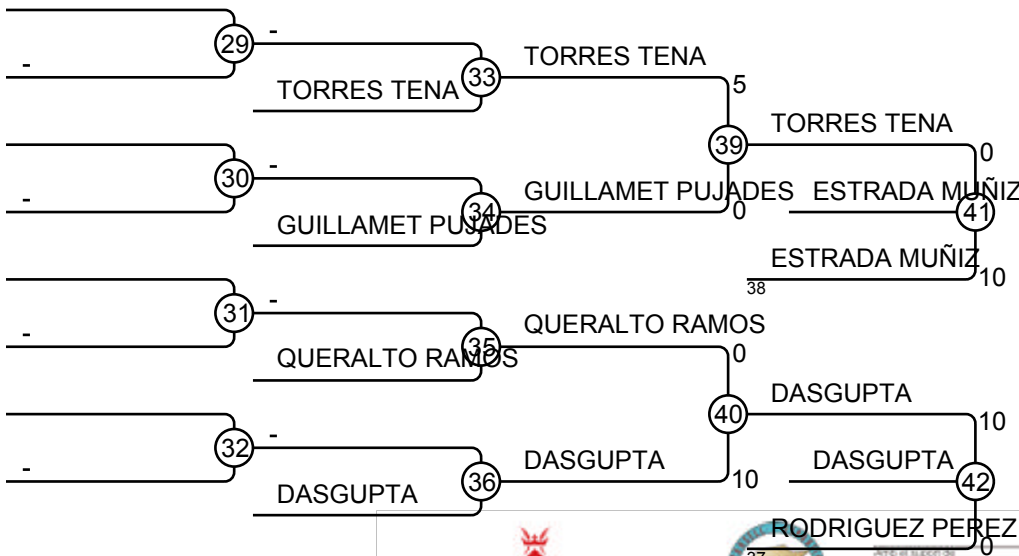

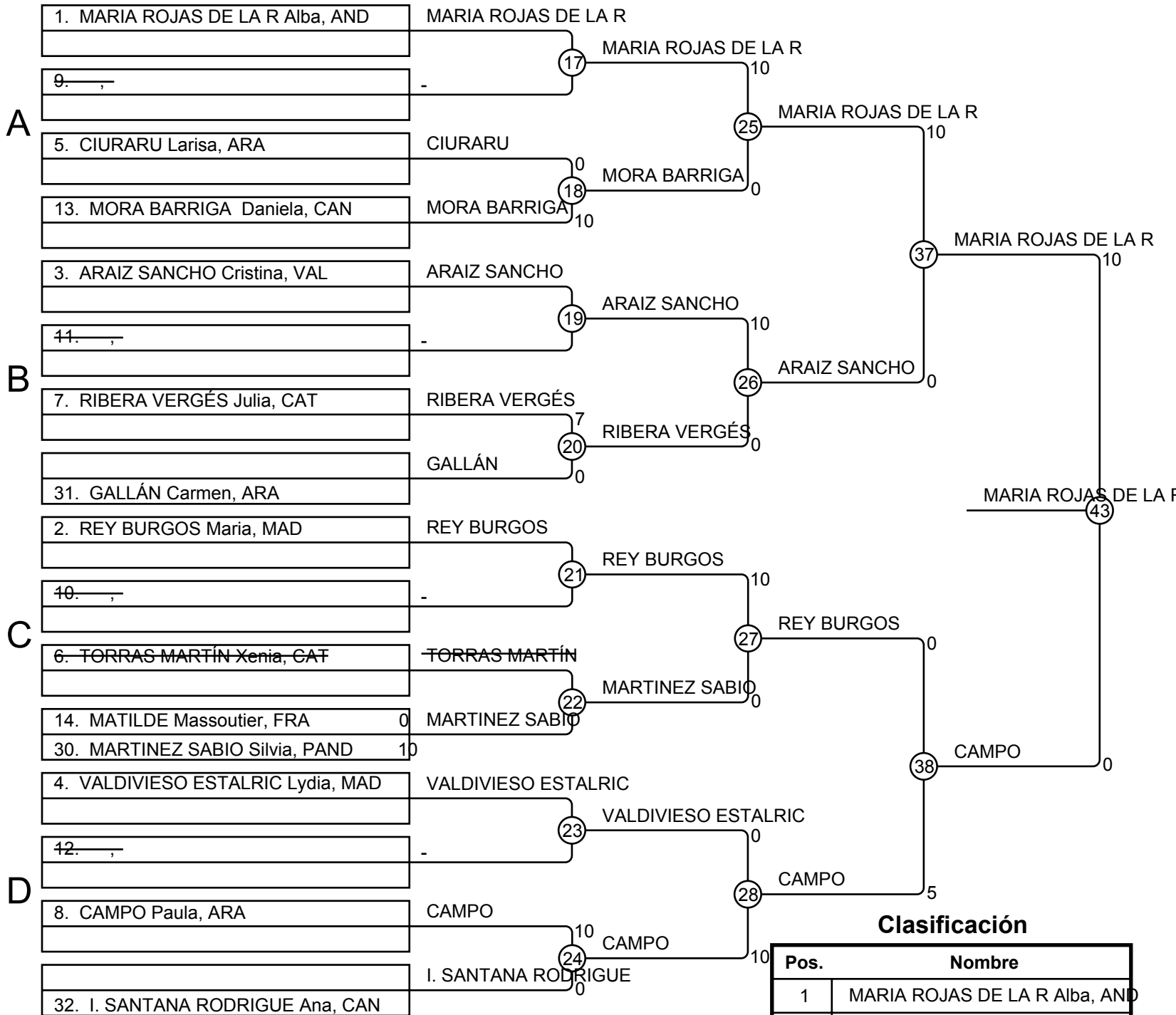

**Clasificación**

Pos.	Nombre
1	MARIA ROJAS DE LA R Alba, AND
2	CAMPO Paula, ARA
3	RIBERA VERGÉS Julia, CAT
3	ARAIZ SANCHO Cristina, VAL
5	REY BURGOS Maria, MAD
5	VALDIVIESO ESTALRIC Lydia, MAD
7	MORA BARRIGA Daniela, CAN
7	MARTINEZ SABIO Silvia, PAND

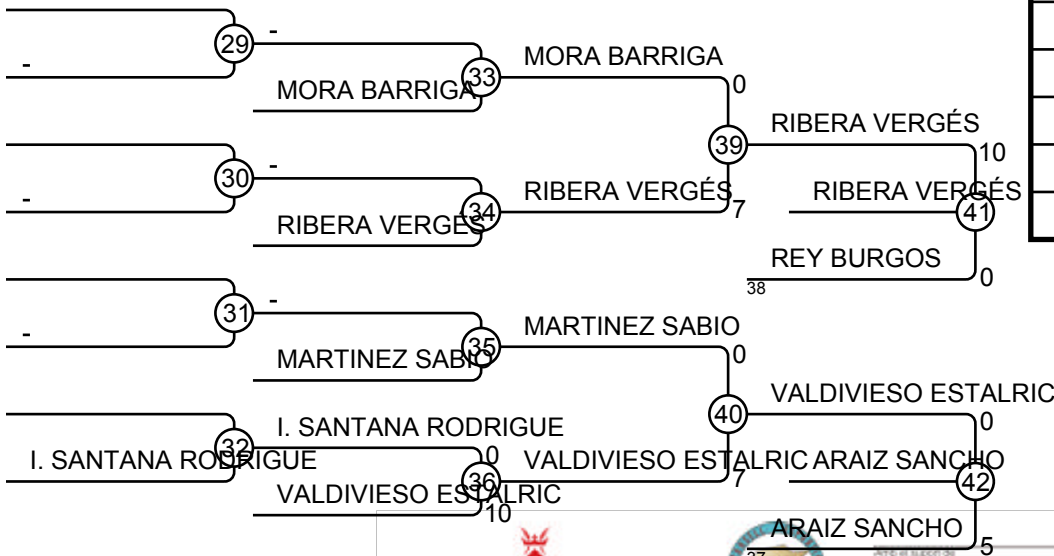

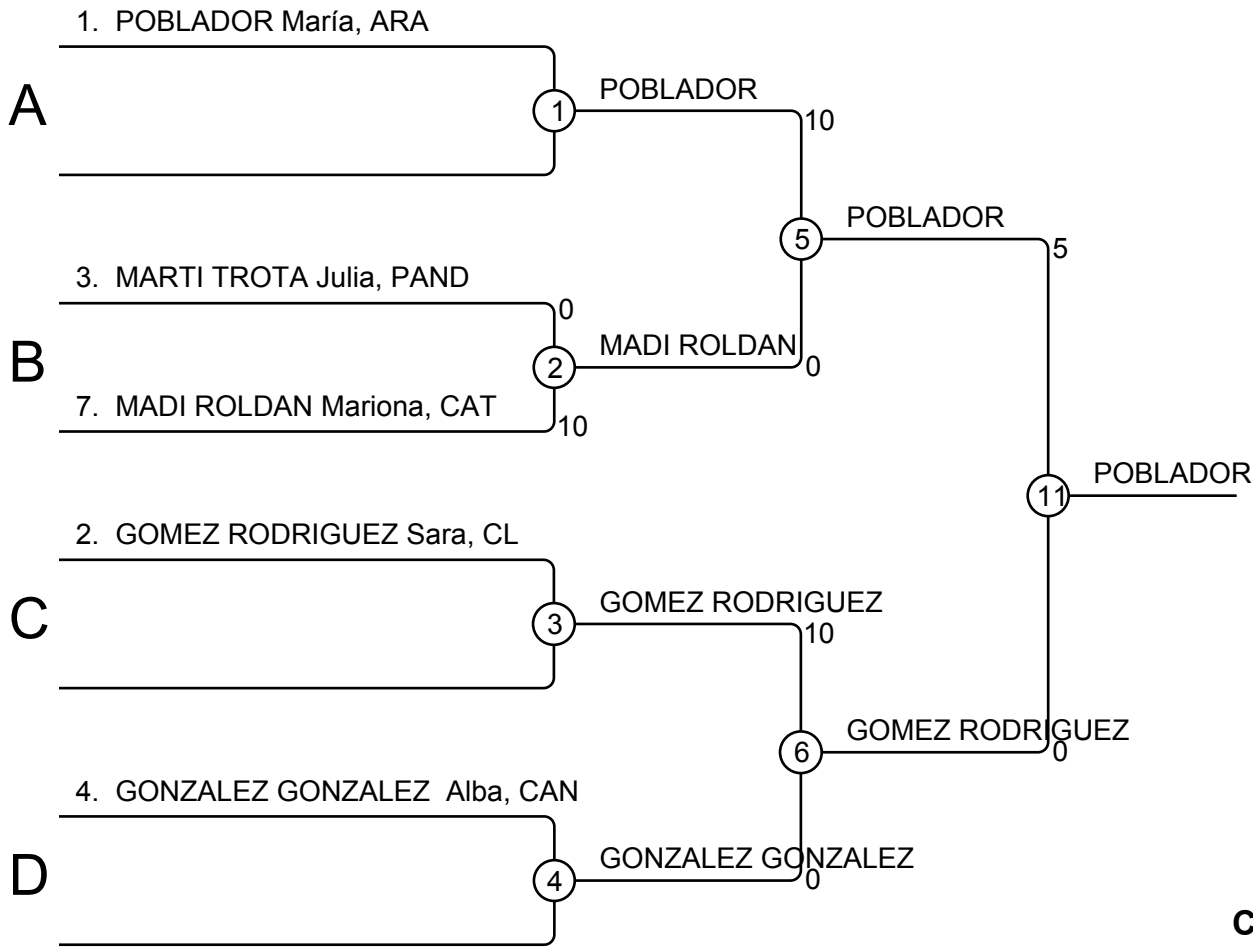

**Clasificación**

Pos.	Nombre
1	POBLADOR María, ARA
2	GOMEZ RODRIGUEZ Sara, CL
3	MARTI TROTA Julia, PAND
3	MADI ROLDAN Mariona, CAT
5	GONZALEZ GONZALEZ Alba, CAN
5	
7	
7	

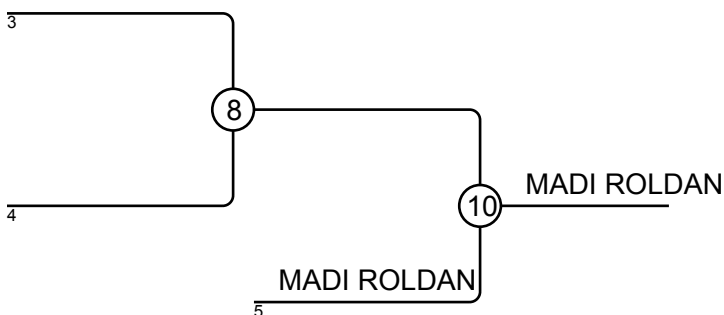
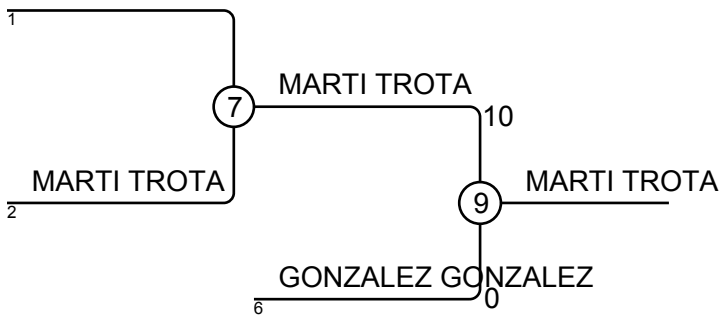

**Competidores**

Nº	Nombre	Club	1	2	3	Victs.	Pts.	Pos.
1	VILLEGAS LAHUERTA Xiomara	VAL			10	1	10	2
2	MARTINEZ SANCHEZ Anna	CAT	10		10	2	20	1
3	PEREZ MARTINEZ Yaiza	AST				0	0	3

**Combates**

Comb.	Blanco	Azul	Resultado	Tiempo
1	VILLEGAS LAHUERTA Xiomara 1 2	MARTINEZ SANCHEZ Anna	0 - 10	0:27
2	VILLEGAS LAHUERTA Xiomara 1 3	PEREZ MARTINEZ Yaiza	10 - 0	0:42
3	MARTINEZ SANCHEZ Anna 2 3	PEREZ MARTINEZ Yaiza	10 - 0	0:25

**Clasificación**

Pos.	Nombre
1	MARTINEZ SANCHEZ Anna, CAT
2	VILLEGAS LAHUERTA Xiomara, VAL
3	PEREZ MARTINEZ Yaiza, AST



A

1. LÓPEZ ONTIVEROS Eduardo, MAD	LÓPEZ ONTIVEROS
33. —, —	
9. GARCÍA FAJARDO Gonzalo, VAL	GARCÍA FAJARDO
25. TUR BONVEHI Abel, CAT	TUR BONVEHI
5. KOVALCHUK Igor, VAL	KOVALCHUK
37. —, —	
45. PLAZAS CANETE Gonzalo, CAT	PLAZAS CANETE
29. JORDA ALVENTOSA Alvaro, VAL	JORDA ALVENTOSA
61. AURELIEN Santoni, FRA	
3. ALONSO Mario, AST	ALONSO
35. —, —	
11. TORRES MINAYA Isaac, CLM	TORRES MINAYA
59. CERVERA CANOS Marc, VAL	CERVERA CANOS
7. KOLSTER BORGES Arturo, MAD	KOLSTER BORGES
39. —, —	
15. FERRER ALMANSA Roberto, VAL	FERRER ALMANSA
31. BORRAS EROLA Toni, CAT	BORRAS EROLA

B

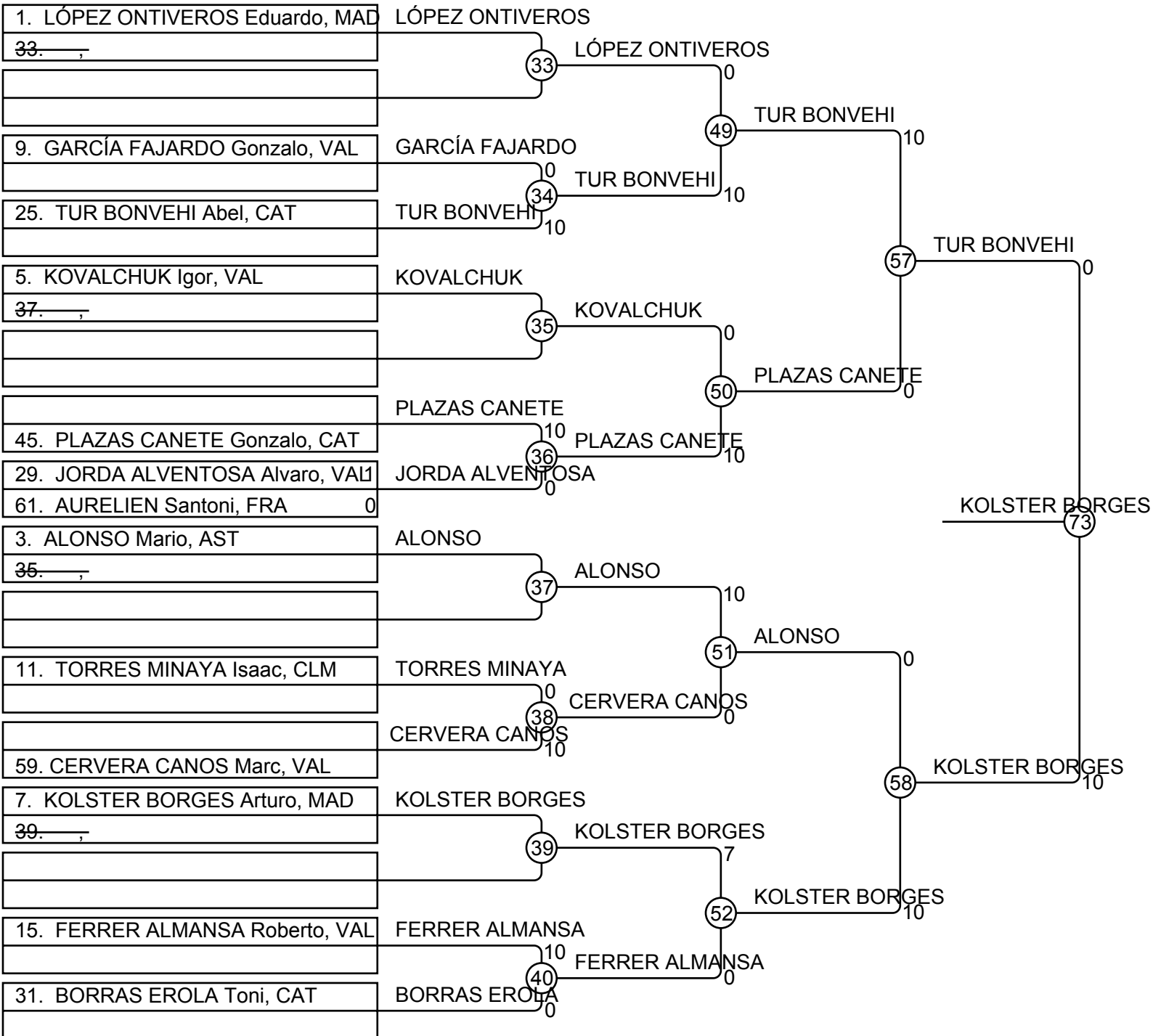

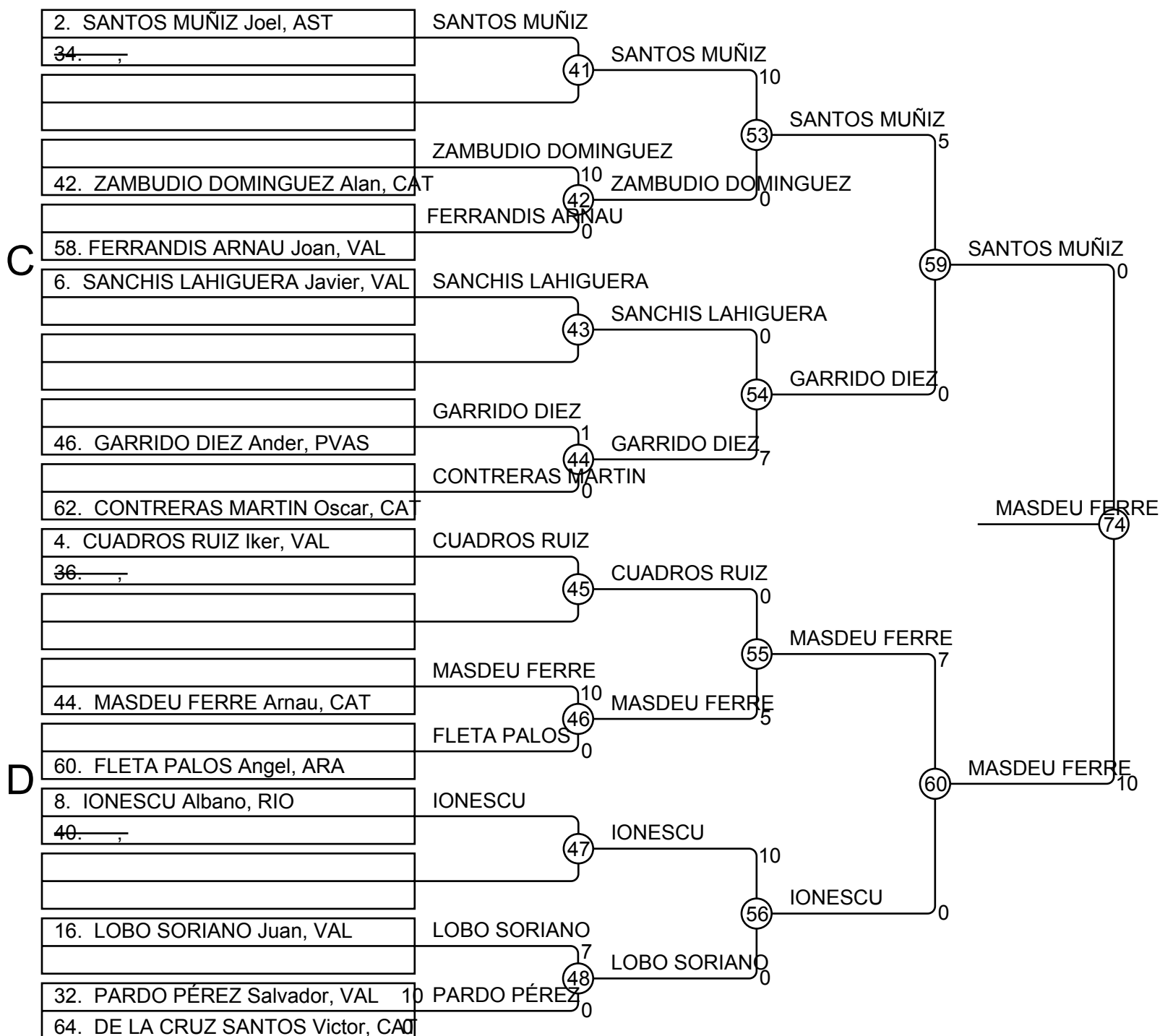

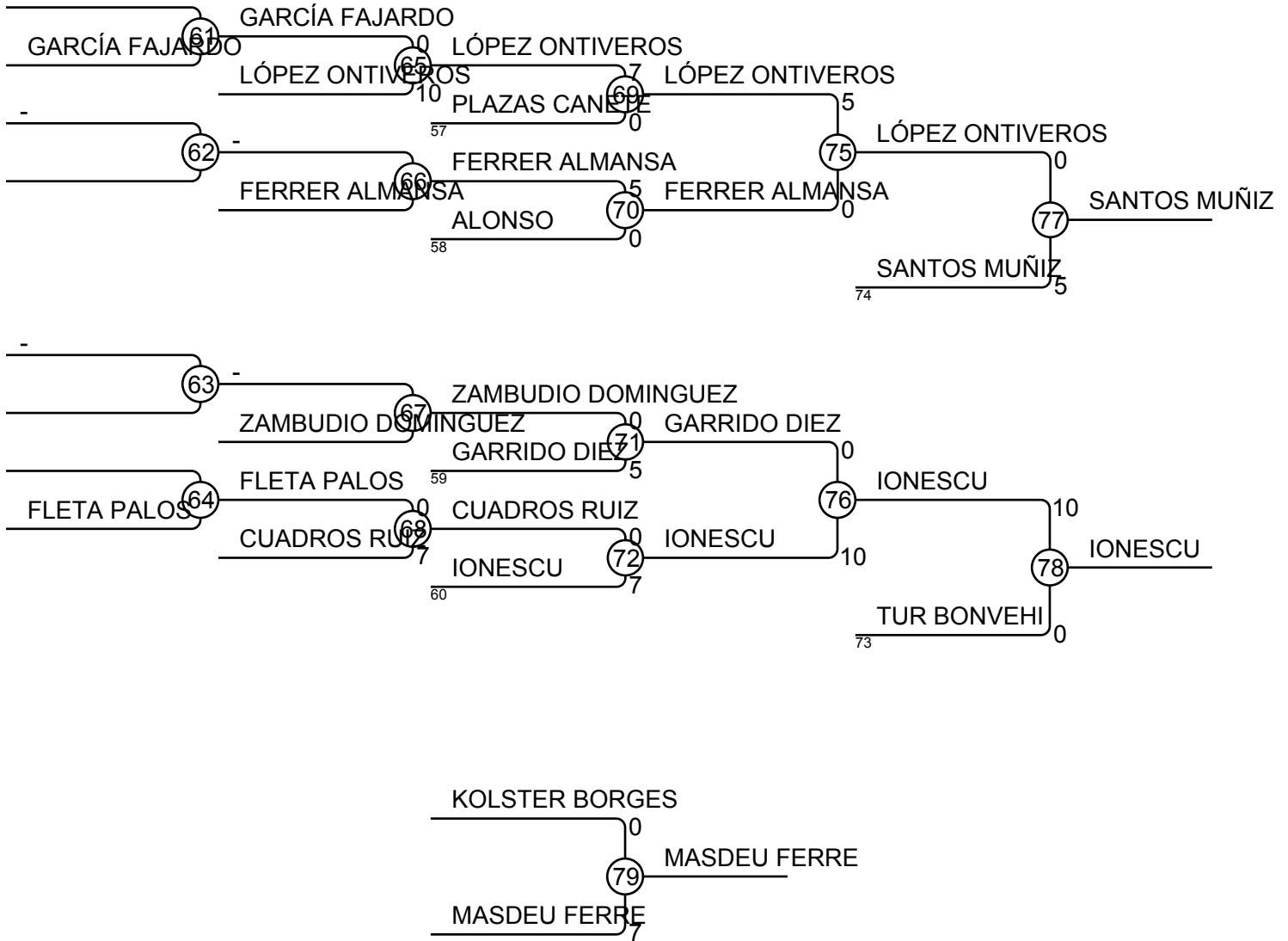

**Clasificación**

Pos.	Nombre
1	MASDEU FERRE Arnau, CAT
2	KOLSTER BORGES Arturo, MAD
3	SANTOS MUÑIZ Joel, AST
3	IONESCU Albano, RIO
5	LÓPEZ ONTIVEROS Eduardo, MAD
5	TUR BONVEHI Abel, CAT
7	FERRER ALMANSA Roberto, VAL
7	GARRIDO DIEZ Ander, PVAS

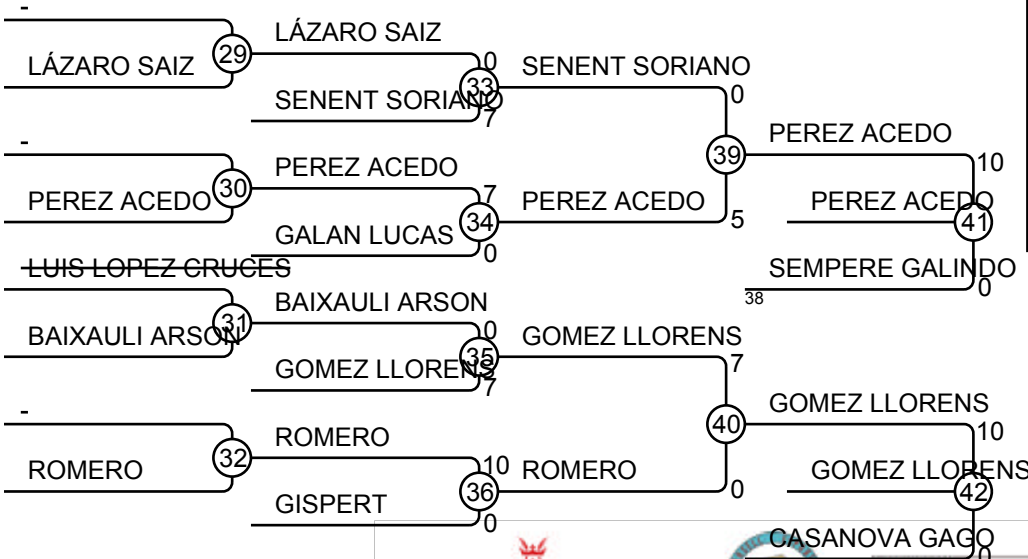
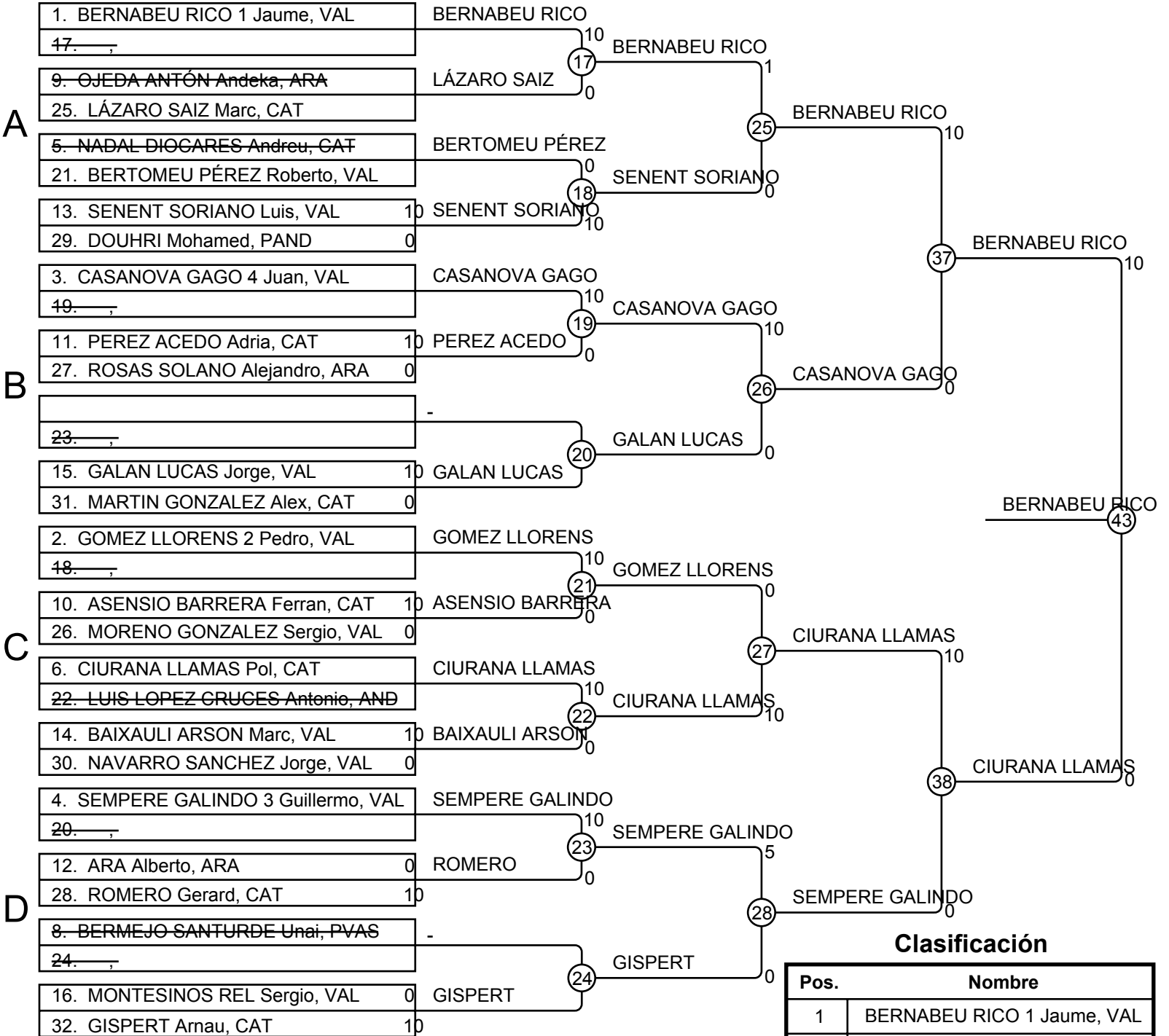

A

1. FERNANDEZ CAMPILLO Diego, MAD	FERNANDEZ CAMPILLO
33. —, —	
17. —, —	
9. RAMON CORRAL Oscar, CAT	RAMON CORRAL
25. NAVARRO DE BRITO Miguel, VAL	NAVARRO DE BRITO
5. MIRANDA ALONSO Raúl, CAN	MIRANDA ALONSO
21. BUITRAGO RIVERA Fernando, SHI	BUITRAGO RIVERA
13. LORENTE PALANCA Sergio, VAL	LORENTE PALANCA
61. TORRAS MAJO Guifre, CAT	TORRAS MAJO
3. LLOPE Iyan, AST	LLOPE
49. —, —	
41. DIAZ ABELLAN Pablo, MUR	FANDOS PLANELLES
43. FANDOS PLANELLES Santiago, VAL	QUEROL ILARI
27. QUEROL ILARI Andreu, CAT	QUEROL ILARI
7. BENAVIDES BELLERAUT Luis, CAN	BENAVIDES BELLERAUT
23. —, —	
15. BAUDRY MONTANE Arnaud, CAT	ESTEVES REYES
47. ESTEVES REYES Hector, NAV	PUNZANO CASTELLO
63. PUNZANO CASTELLO Paco, VAL	PUNZANO CASTELLO

B

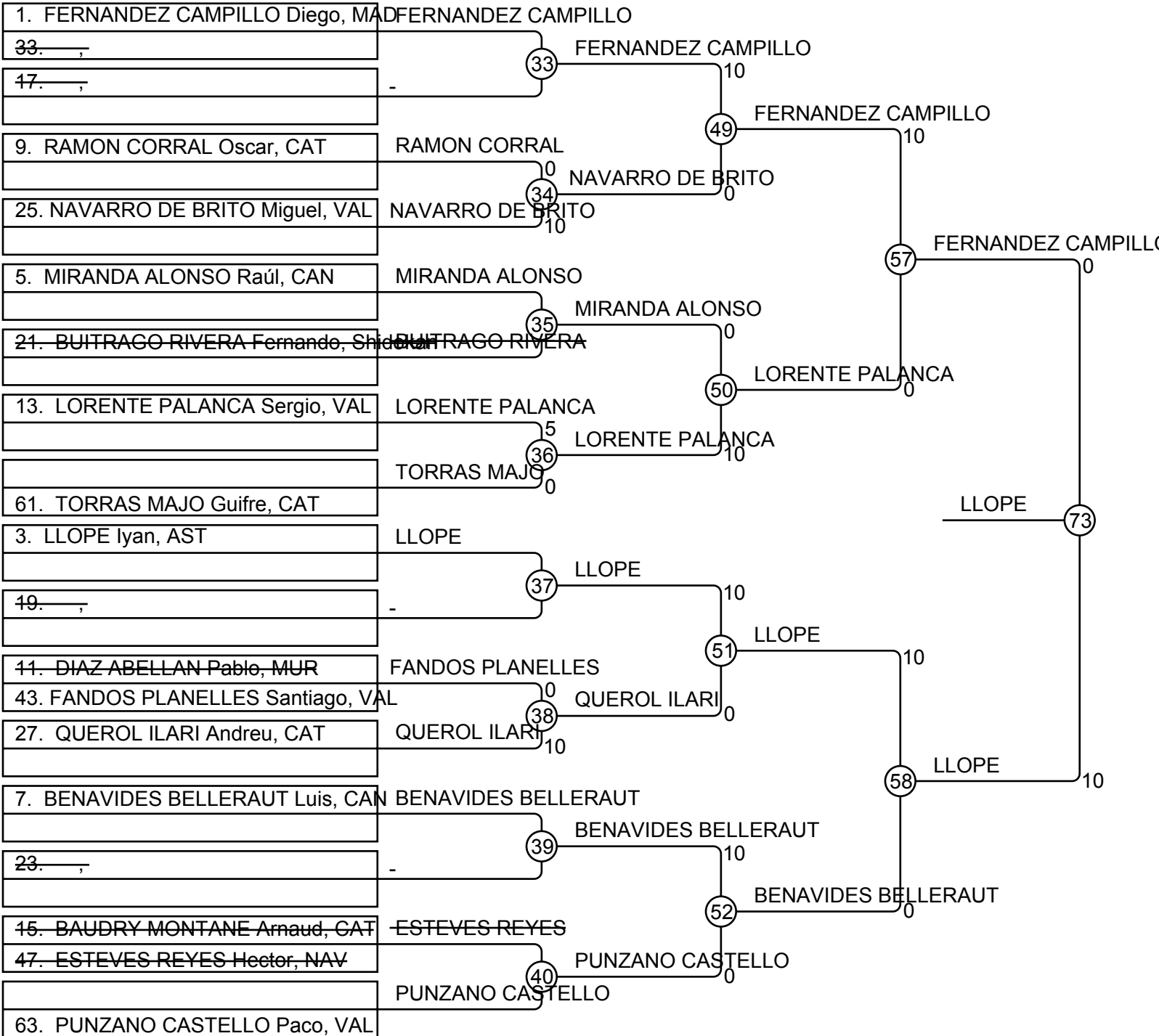



FEDERACIÓ CATALANA DE JOUJODA



Tortosa 18 de Enero 2015

Súper Copa de España Infantil Internacional Ebreña

Inf M -46

C

D

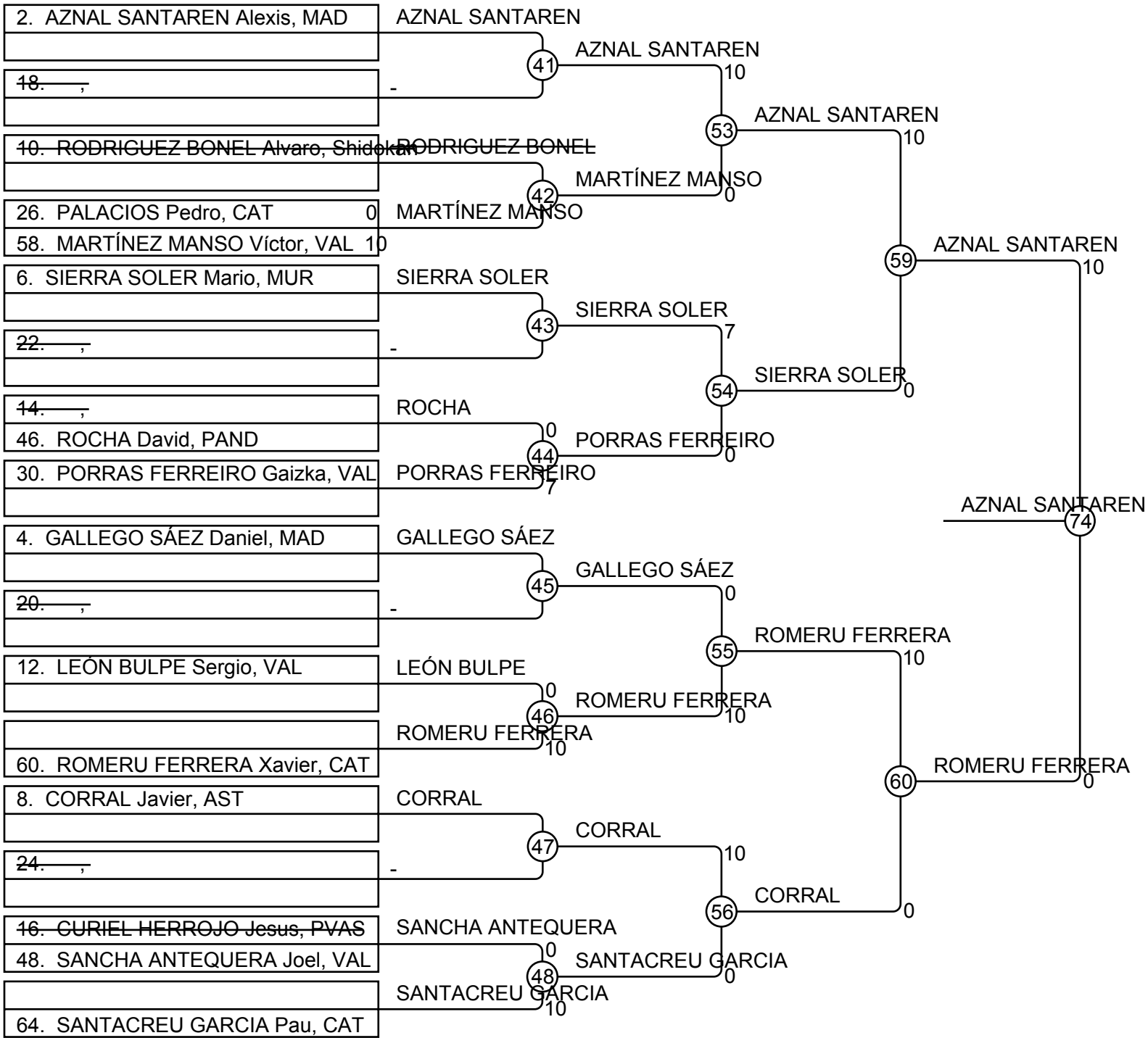

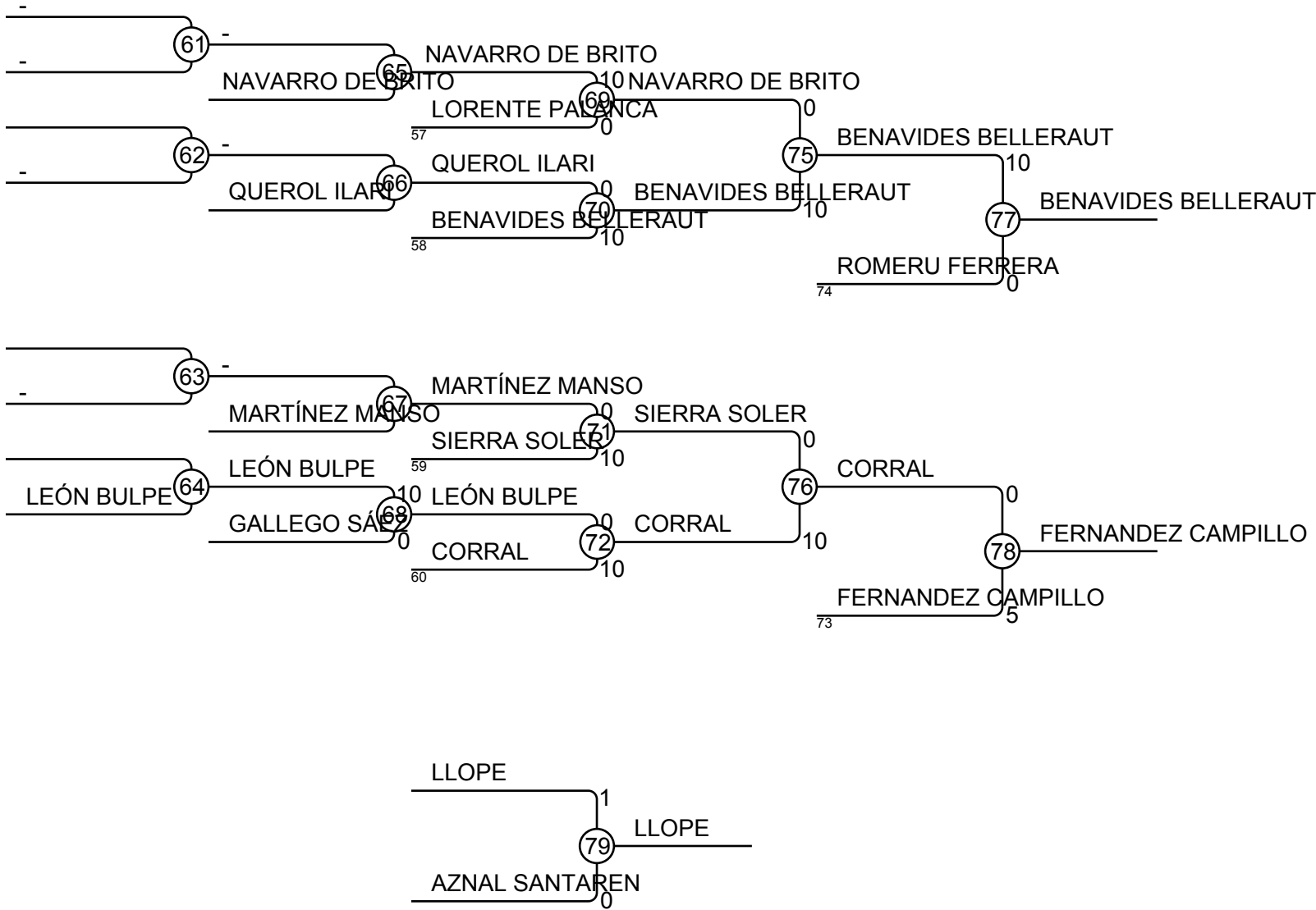

**Clasificación**

Pos.	Nombre
1	LLOPE Iyan, AST
2	AZNAL SANTAREN Alexis, MAD
3	BENAVIDES BELLERAUT Luis, CAN
3	FERNANDEZ CAMPILLO Diego, MA
5	ROMERU FERRERA Xavier, CAT
5	CORRAL Javier, AST
7	NAVARRO DE BRITO Miguel, VAL
7	SIERRA SOLER Mario, MUR

**A**

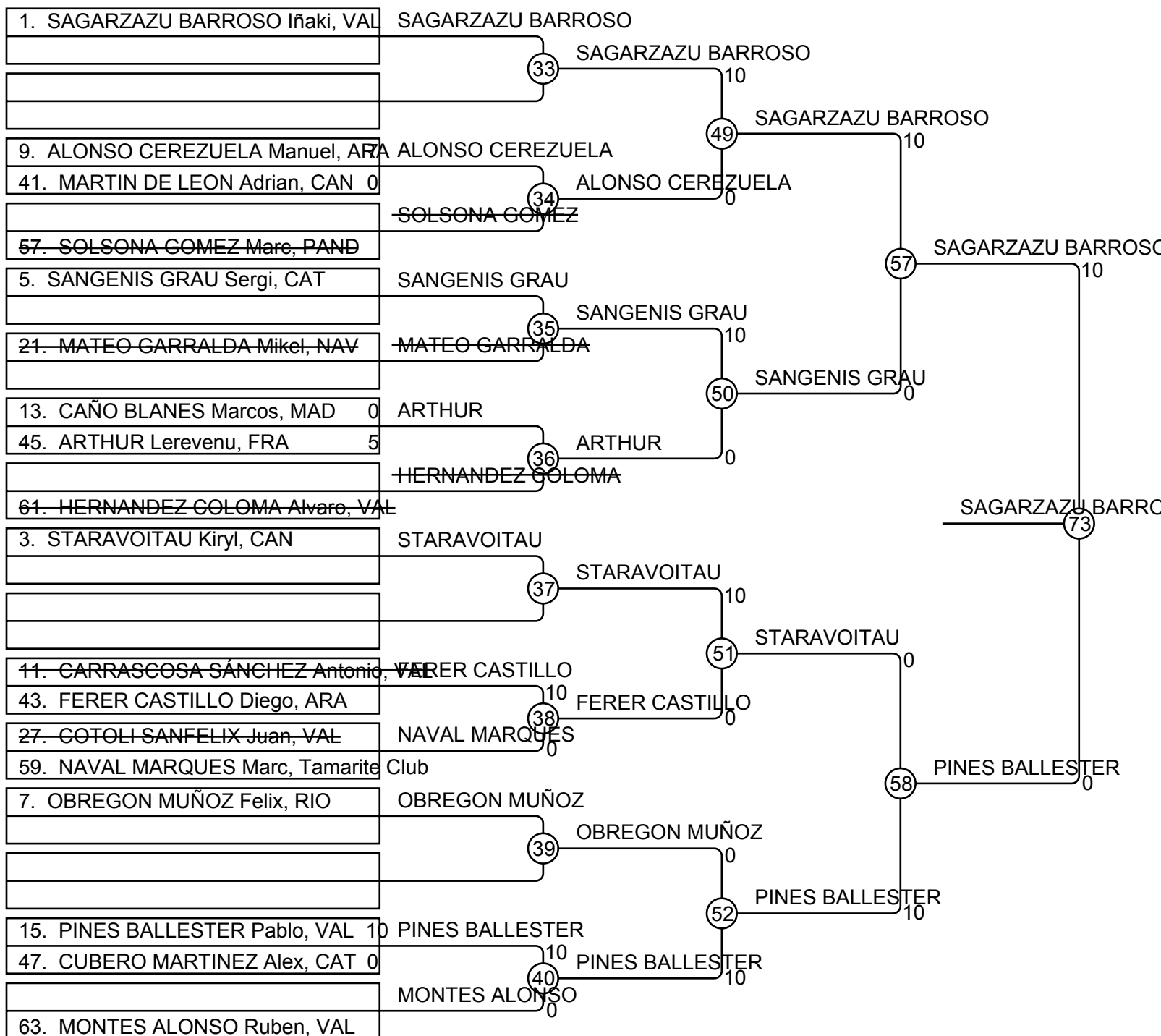

**B**



C

D

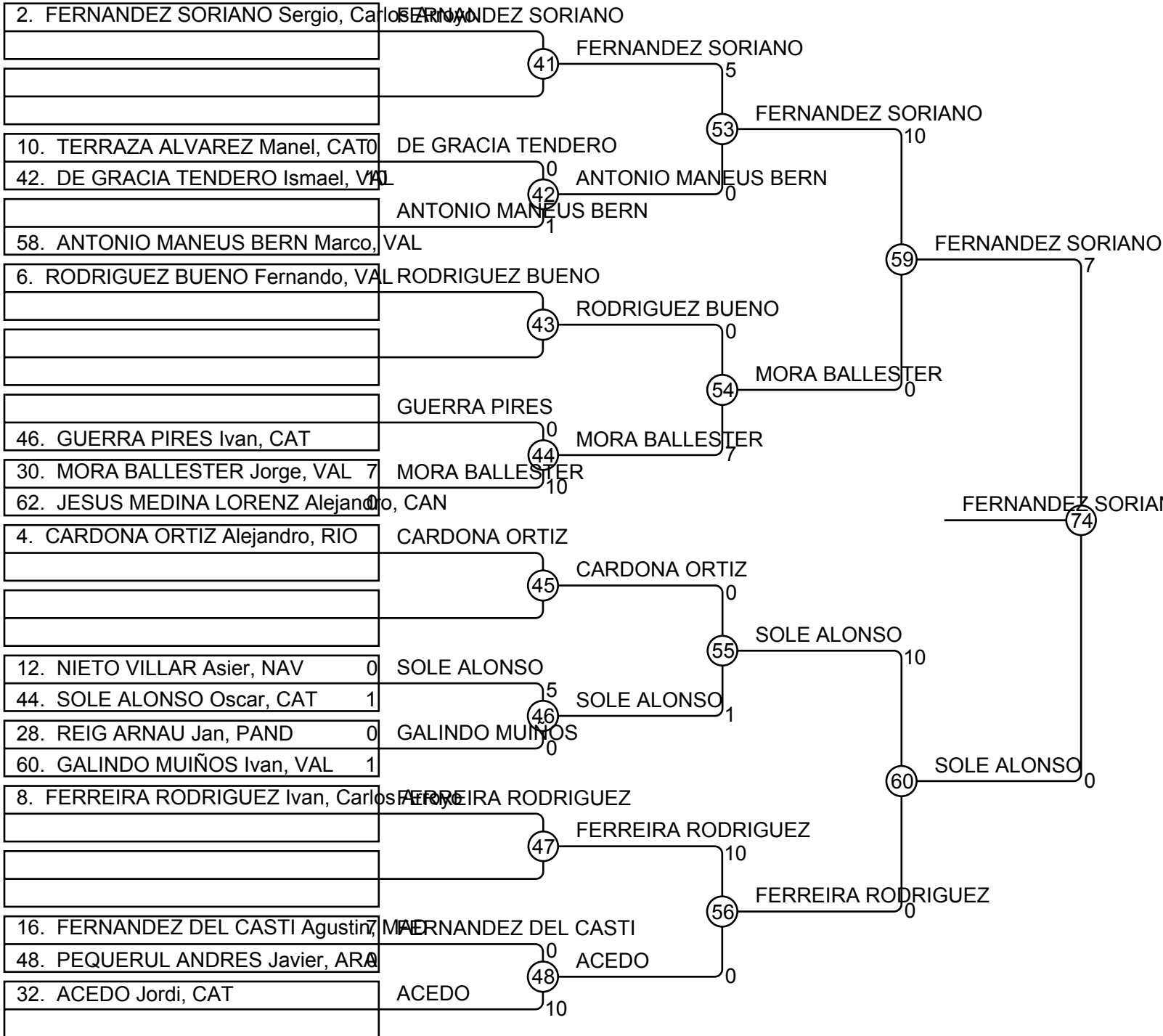

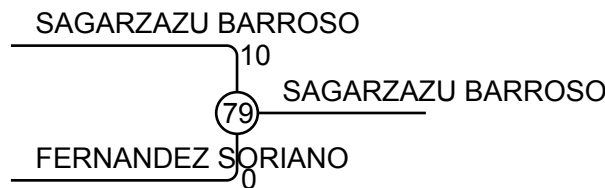
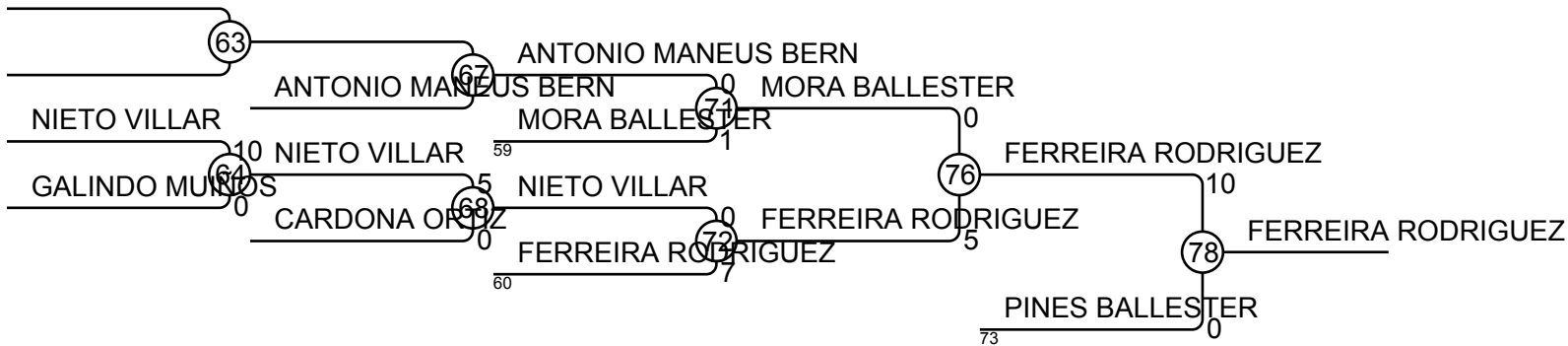
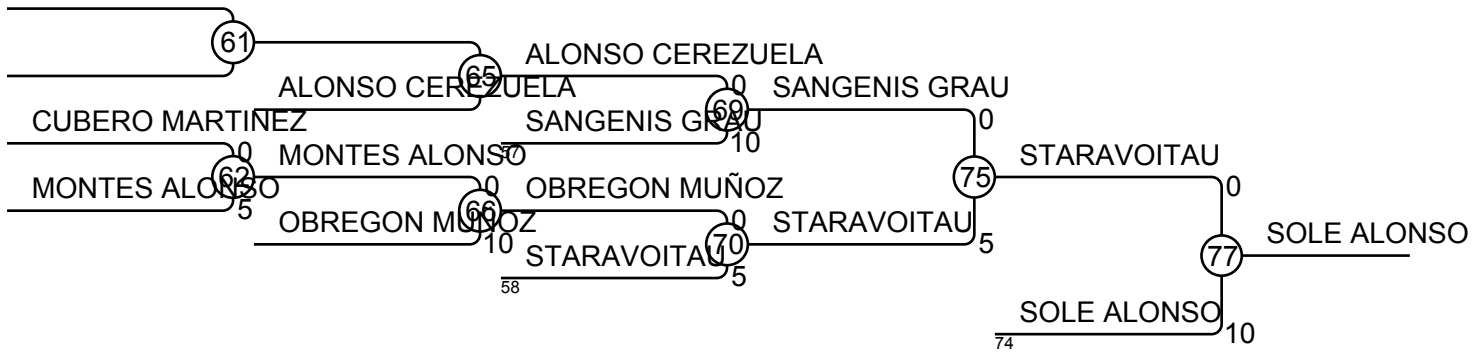

**Clasificación**

Pos.	Nombre
1	SAGARZAZU BARROSO Iñaki, VAL
2	FERNANDEZ SORIANO Sergio, VA
3	SOLE ALONSO Oscar, CAT
3	FERREIRA RODRIGUEZ Ivan, VA
5	STARAVOITAU Kiryl, CAN
5	PINES BALLESTER Pablo, VA
7	SANGENIS GRAU Sergi, CAT
7	MORA BALLESTER Jorge, VA

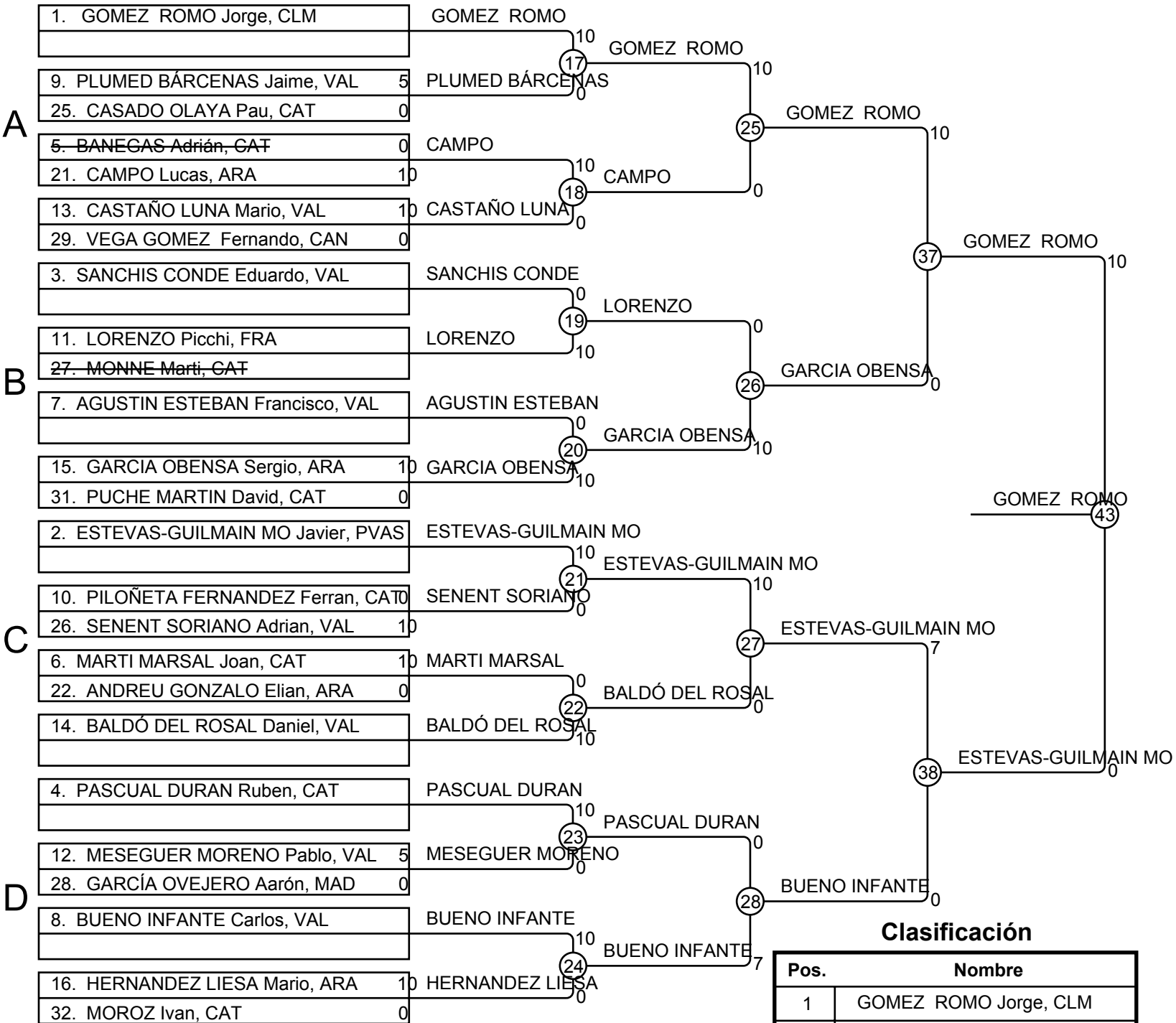

**Clasificación**

Pos.	Nombre
1	GOMEZ ROMO Jorge, CLM
2	ESTEVAS-GUILMAIN MO Javier, PVAS
3	BUENO INFANTE Carlos, VAL
3	SENENT SORIANO Adrian, VAL
5	CAMPO Lucas, ARA
5	GARCIA OBENSA Sergio, ARA
7	AGUSTIN ESTEBAN Francisco, VAL
7	PASCUAL DURAN Ruben, CAT

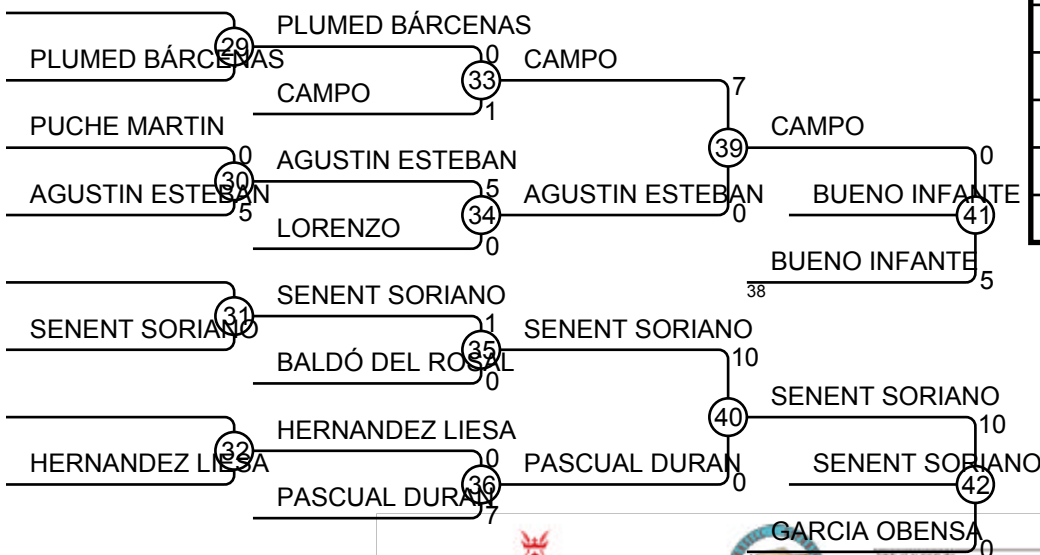

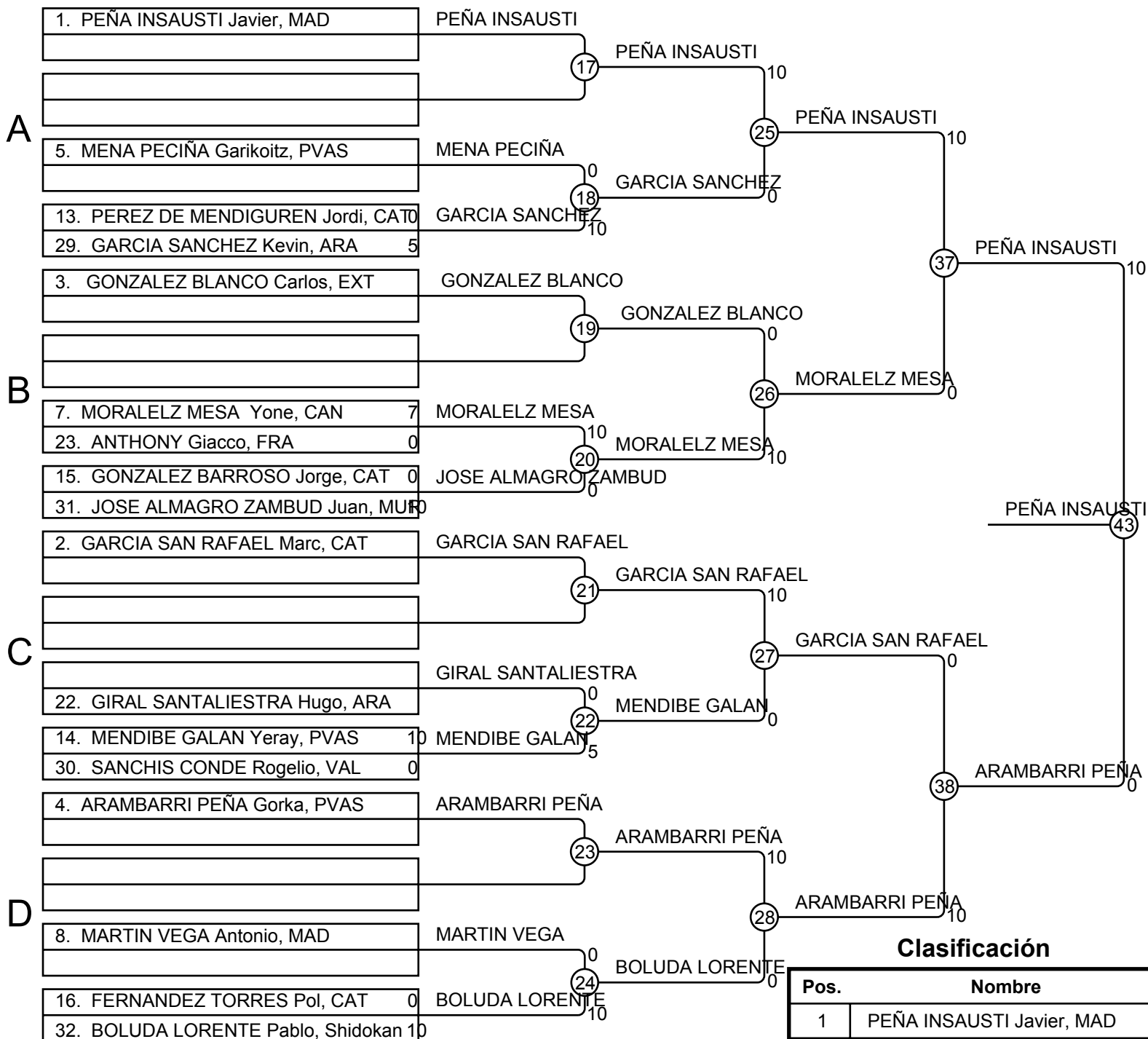

**Clasificación**

Pos.	Nombre
1	PEÑA INSAUSTI Javier, MAD
2	ARAMBARRI PEÑA Gorka, PVAS
3	GARCIA SAN RAFAEL Marc, CAT
3	MORALELZ MESA Yone, CAN
5	GARCIA SANCHEZ Kevin, ARA
5	MENDIBE GALAN Yeray, PVAS
7	GONZALEZ BLANCO Carlos, EXT
7	BOLUDA LORENTE Pablo,

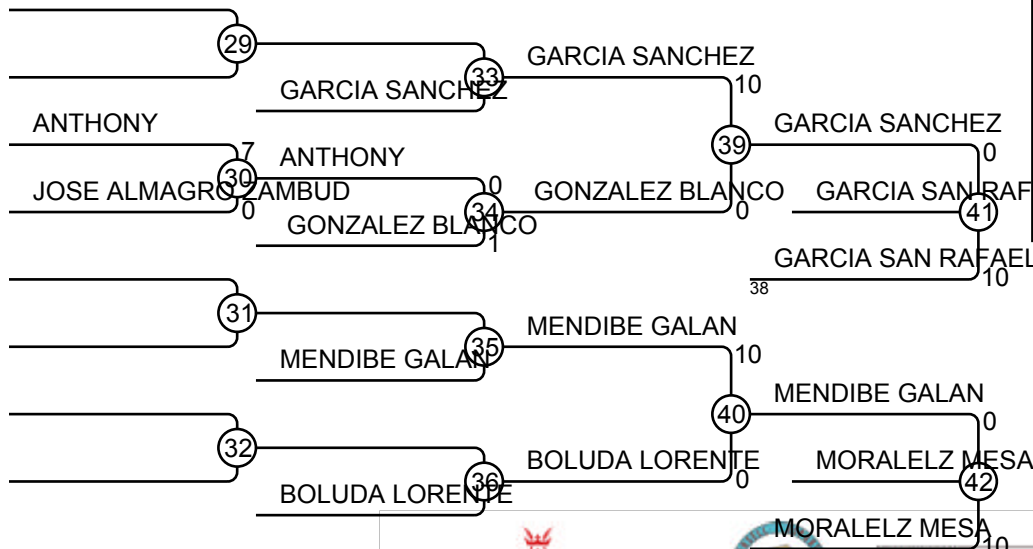

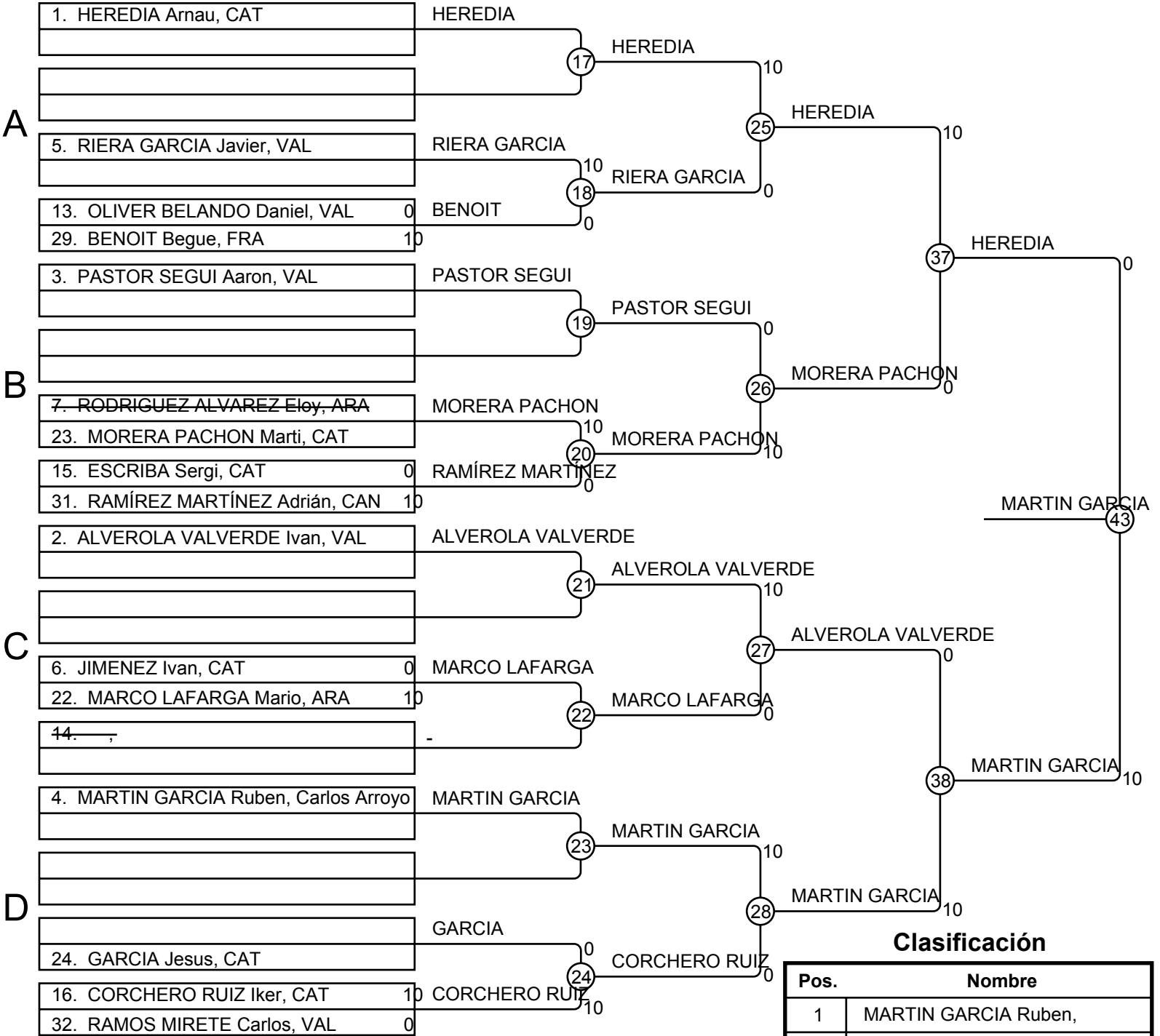

**Clasificación**

Pos.	Nombre
1	MARTIN GARCIA Ruben,
2	HEREDIA Arnau, CAT
3	ALVEROLA VALVERDE Ivan, VAL
3	MORERA PACHON Marti, CAT
5	RIERA GARCIA Javier, VAL
5	MARCO LAFARGA Mario, ARA
7	RAMÍREZ MARTÍNEZ Adrián, CAN
7	CORCHERO RUIZ Iker, CAT

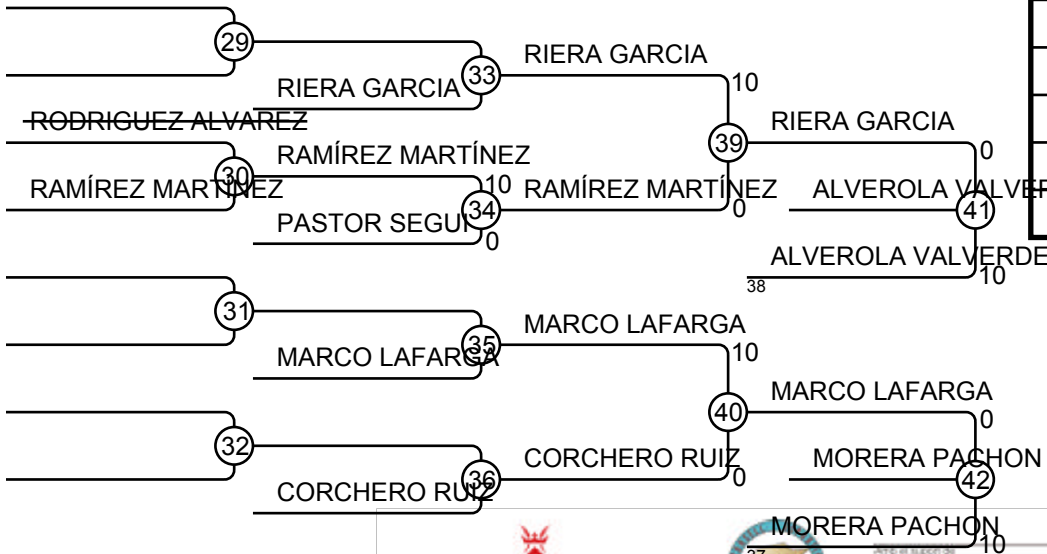

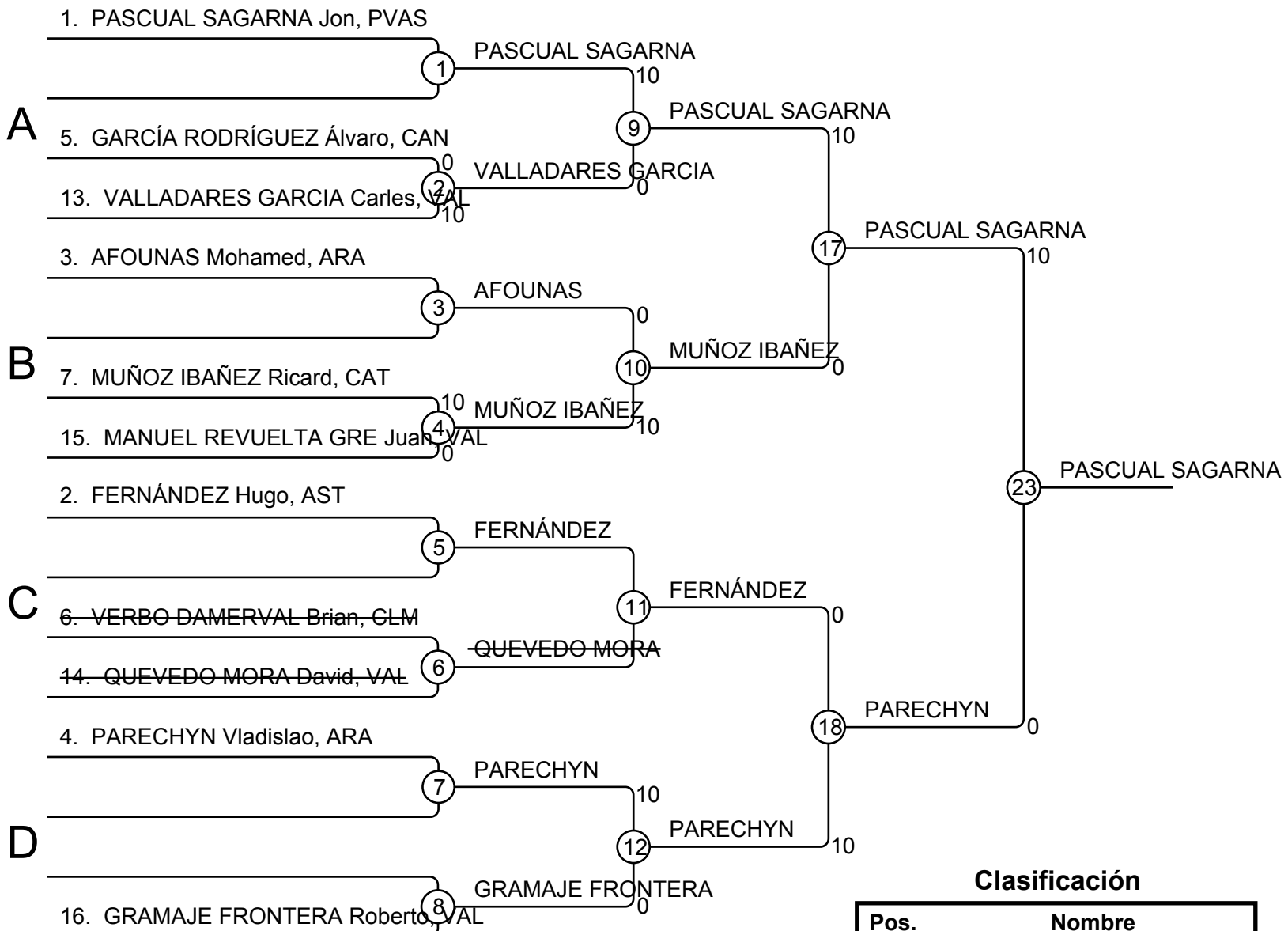

**Clasificación**

Pos.	Nombre
1	PASCUAL SAGARNA Jon, PVAS
2	PARECHYN Vladislao, ARA
3	MANUEL REVUELTA GRE Juan, VAL
3	MUÑOZ IBAÑEZ Ricard, CAT
5	FERNÁNDEZ Hugo, AST
5	GRAMAJE FRONTERA Roberto, VAL
7	VALLADARES GARCIA Carles, VAL
7	

